

PBR | PBU

SIGNATURE[®] 200 | Siliconized Polyester



TRUE BLACK
26/24 ga



DEEP GRAY
26 ga



LIGHT STONE
26/24 ga



HAWAIIAN BLUE
26/24 ga



COFFEE BROWN
26/24 ga



DESERT SAND
26 ga



SCARLET RED
26 ga



CHARCOAL GRAY
26/24 ga



RUSTIC RED
26/24 ga



SADDLE TAN
26 ga



ASH GRAY
26 ga



POLAR WHITE
26/24 ga



EVERGREEN
26/24 ga



BURNISHED SLATE
26/24 ga



COBALT BLUE
26 ga

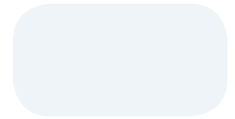

BRIGHT WHITE
26 ga



WINE RED
26 ga



IVY GREEN
26 ga

COMMERCIAL - ARCHITECTURAL COOL COLORS

Includes PBD / PBC / AVP.
All Signature 200 colors are Cool Roof compliant through the CRRC-1 Program.
Visit coolroofs.org for more details.

For the most current information
available, visit our website at
www.reddotbuildings.com

COMMERCIAL-ARCHITECTURAL

PANEL PROFILES

Commercial Panel Profiles

| | |
|--------------------|--------------------|
| <p>"PBR" PANEL</p> | <p>"PBD" PANEL</p> |
| <p>"PBU" PANEL</p> | <p>7.2 PANEL</p> |
| <p>"PBC" PANEL</p> | <p>"AVP" PANEL</p> |

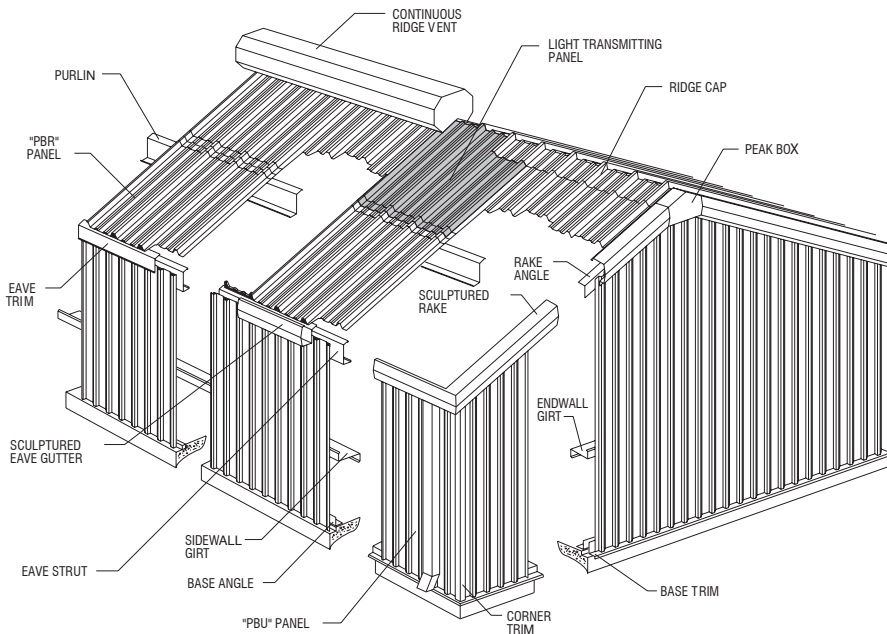

AVAILABLE ACCESSORIES

- Hat and Channel Sections
- Light Transmitting Panels
- Vents
- Roof Jacks
- Fasteners
- Ridge Caps
- Closures
- Doors
- Windows
- Sealants
- Insulation
- Bracing
- Bolts
- Louvers
- Sliding Door Hardware

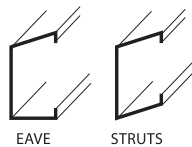
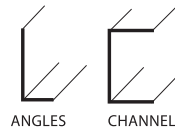
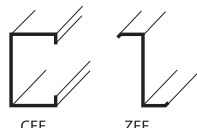

Architectural Panel Profiles

Standing Seam Vertical Leg

LOKSEAM®

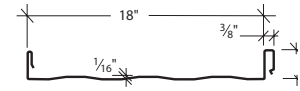

Snap-Together System
12" and 16" also available

BATTENLOK® HS

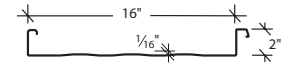

Field Seamed System
12" also available

SUPERLOK®

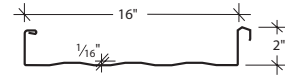

Field Seamed System
12" also available

CURVED BATTENLOK®

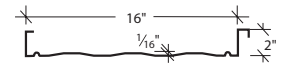

Field Seamed System
Must be curved by a 3rd party before installation

Trapezoidal Leg

ULTRA-DEK®

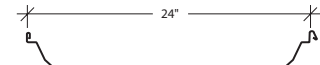

Snap-Together System
12" and 18" also available

DOUBLE-LOK®

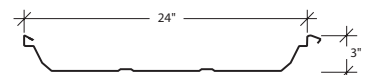

Field Seamed System
12" and 18" also available

SHADOWRIB™

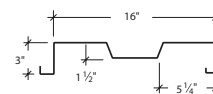

ARTISAN® SERIES

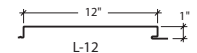

NUWALL®

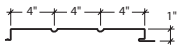
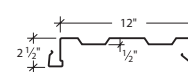

8" and 10" also available

QWIKLOK™



FW 120-1

