

**PBR | PBU**

**SIGNATURE<sup>®</sup> 300** | Polyvinylidene Fluoride (PVDF) Low Gloss



**BRITE RED**  
26 ga



**MEDIUM BRONZE**  
26 ga

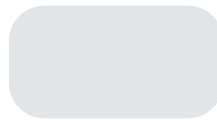

**SNOW WHITE**  
26/24 ga



**SLATE GRAY**  
26 ga



**ALMOND**  
26/24 ga



**HARBOR BLUE**  
26 ga



**STORM GRAY**  
26 ga



**CLASSIC GREEN**  
26 ga



**MIDNIGHT BLACK**  
24 ga



**PACIFIC BLUE**  
24 ga



**BROWNSTONE**  
26/24 ga



**BONE WHITE**  
26 ga



**MIDNIGHT BRONZE**  
24 ga



**TUNDRA**  
24 ga



**COLONIAL RED**  
24 ga

COMMERCIAL - ARCHITECTURAL COOL COLORS

Includes PBD / PBC / AVP.  
All Signature 300 colors are Cool Roof compliant through the CRRC-1 Program.  
Visit [coolroofs.org](http://coolroofs.org) for more details.

For the most current information available, visit our website at [www.reddotbuildings.com](http://www.reddotbuildings.com)

# COMMERCIAL-ARCHITECTURAL

## PANEL PROFILES

### Commercial Panel Profiles

<p>"PBR" PANEL</p>	<p>"PBD" PANEL</p>
<p>"PBU" PANEL</p>	<p>7.2 PANEL</p>
<p>"PBC" PANEL</p>	<p>"AVP" PANEL</p>

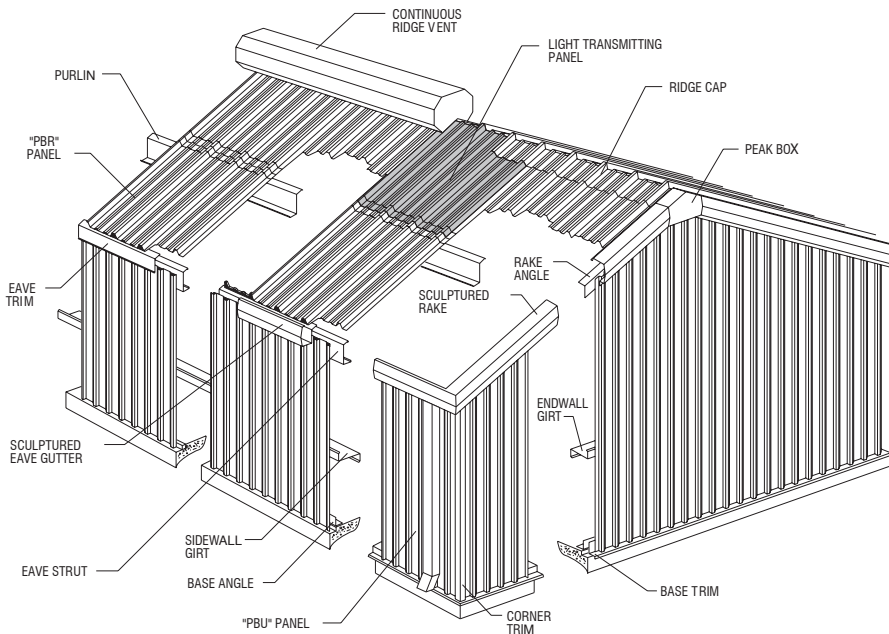

#### AVAILABLE ACCESSORIES

- Hat and Channel Sections
- Light Transmitting Panels
- Vents
- Roof Jacks
- Fasteners
- Ridge Caps
- Closures
- Doors
- Windows
- Sealants
- Insulation
- Bracing
- Bolts
- Louvers
- Sliding Door Hardware

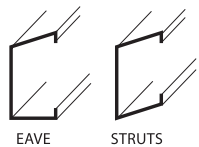
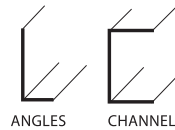
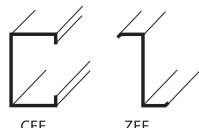

### Architectural Panel Profiles

#### Standing Seam Vertical Leg

##### LOKSEAM®

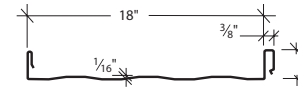

Snap-Together System  
12" and 16" also available

##### BATTENLOK® HS

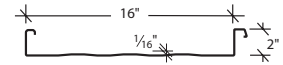

Field Seamed System  
12" also available

##### SUPERLOK®

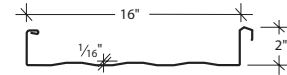

Field Seamed System  
12" also available

##### CURVED BATTENLOK®

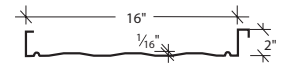

Field Seamed System  
Must be curved by a 3rd party before installation

#### Trapezoidal Leg

##### ULTRA-DEK®

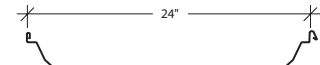

Snap-Together System  
12" and 18" also available

##### DOUBLE-LOK®

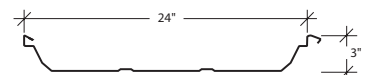

Field Seamed System  
12" and 18" also available

##### SHADOWRIB™

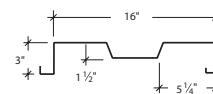

##### ARTISAN® SERIES

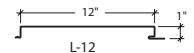

##### NUWALL®

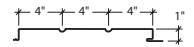
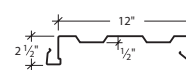

8" and 10" also available

##### QWIKLOK™



##### FW 120-1

